

SPECIFICATIONS

- CONTACT RATING:** Dependent upon contact material See page 18.
- MECHANICAL LIFE:** 30,000 make-and-break cycles.
- CONTACT RESISTANCE:** 10mΩ max. initial @ 2-4VDC
100mA for both silver and gold plated contacts.
- INSULATION RESISTANCE:** 1,000MΩ min.
- DIELECTRIC STRENGTH:** 1,000 V RMS@sea level.
- OPERATING TEMPERATURE:** -30°C to 85°C.

MATERIALS

- CASE & BUSHING:** Class filled nylon 66, flame retardant, heat stabilized (UL94v-0).
- ACTUATOR:** Brass, chrome plated with internal, O-ring seal at standard.
- SWITCH SUPPORT:** Brass or steel, tin plated.
- SWITCH SUPPORT RETAINER:** Stainless steel.
- CONTACT / TERMINALS:** Copper alloy, with Silver or gold plated.
(See Page 18)

HOW TO ORDER

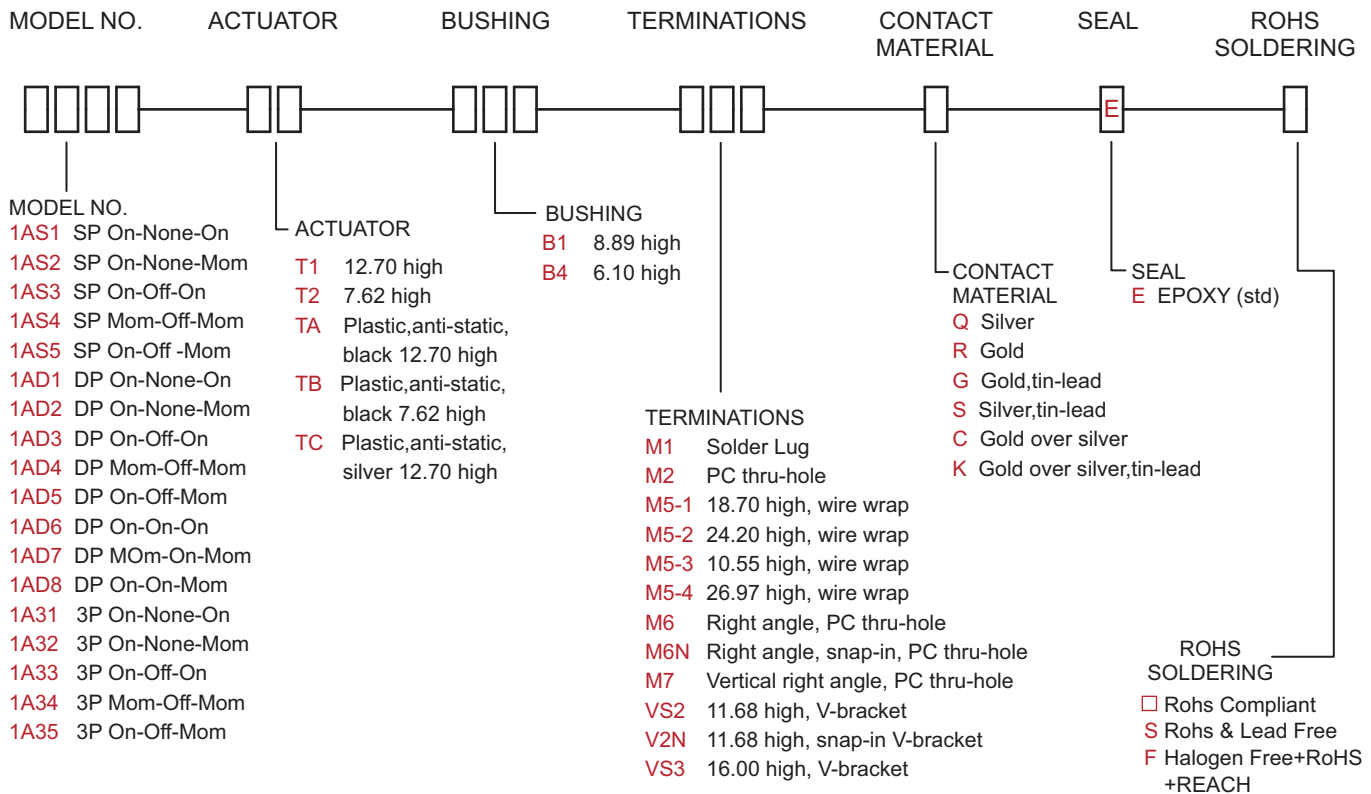

SWITCH FUNCTION

NO. POLES	UL/CSA MODEL NO.	MODEL NO.	SWITCH FUNCTION			CONNECTED TERMINALS / SCHEMATIC		
			POS.1	POS.2	POS.3	POS.1	POS.2	POS.3
SP	Q11A11	1AS1	ON	NONE	ON		N/A	
	Q11A12	1AS2	ON	NONE	MOM			
	Q11A13	1AS3	ON	OFF	ON			
	Q11A14	1AS4	MOM	OFF	MOM			
	Q11A15	1AS5	ON	OFF	MOM			
DP ▲ ▲	Q11A21	1AD1	ON	NONE	ON		N/A	
	Q11A22	1AD2	ON	NONE	MOM			
	Q11A23	1AD3	ON	OFF	ON			
	Q11A24	1AD4	MOM	OFF	MOM			
	Q11A25	1AD5	ON	OFF	MOM			
	Q11A26	1AD6	ON	ON	ON			
	Q11A27	1AD7	MOM	ON	MOM			
	Q11A28	1AD8	ON	ON	MOM			
3P	Q11A31	1A31	ON	NONE	ON		N/A	
	Q11A32	1A32	ON	NONE	MOM			
	Q11A33	1A33	ON	OFF	ON			
	Q11A34	1A34	MOM	OFF	MOM			
	Q11A35	1A35	ON	OFF	MOM			

MOM=MOMENTARY

▲ Please check the availability in advance before order

POLE OPTIONS

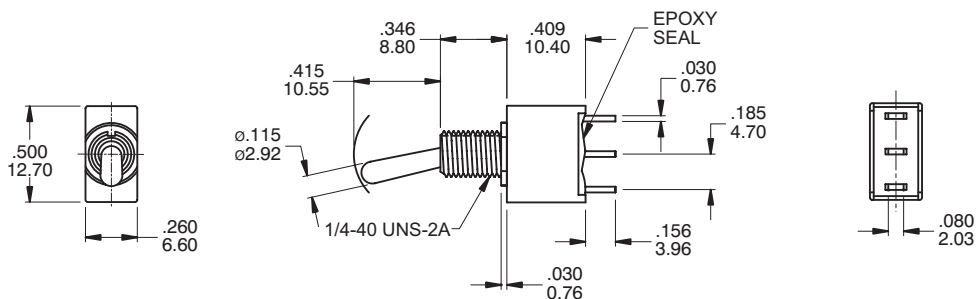

SPDT

Part No. Shown : 1AS1T1B1M1QE

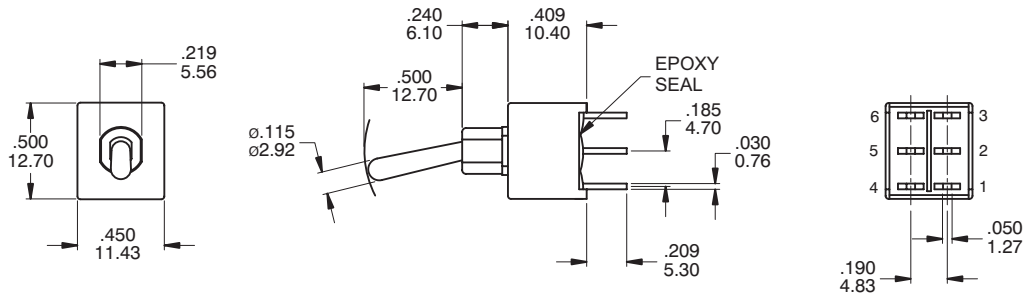

DPDT

Part No. Shown : 1AD1T1B4M2RE

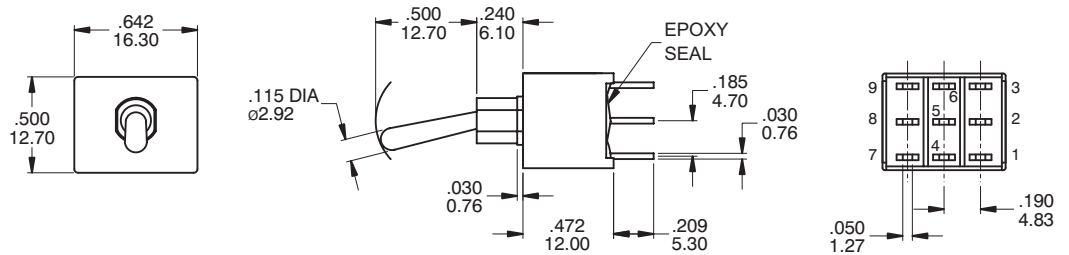

3PDT

Part No. Shown : 1A31T1B4M2RE

ACTUATOR OPTIONS

Actuator shown with standard B4 Bushing,
Subtract .085 (2.15) for B1 bushing.

T1

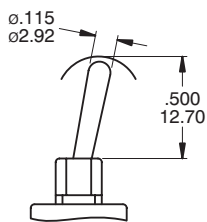

Standard with M1, M2 terminations.

T2

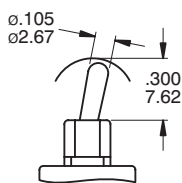

Standard with M6, M7, VS2-3 terminations.

TA

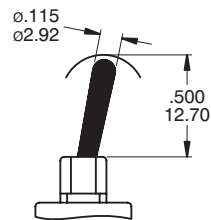

ESD
PLASTIC ACTUATOR
(TC anti-static, silver)

TB

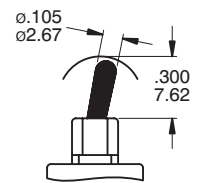

BUSHING OPTIONS

B1

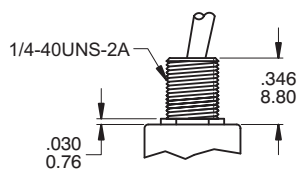

Std for M1

B4

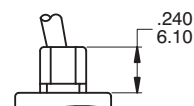

Std for M2, M6, M7, VS termination

TERMINATION OPTIONS

M1 SOLDER LUG

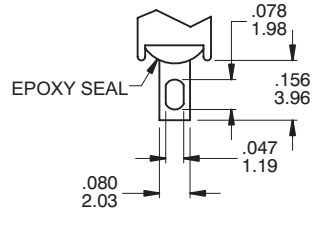

THK .030(0.76)

M2 PC THRU-HOLE

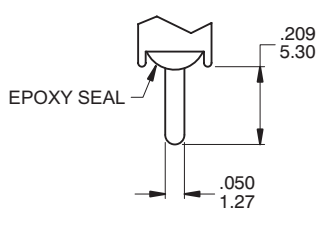

THK .030(0.76)

M3 QUICK CONNECT

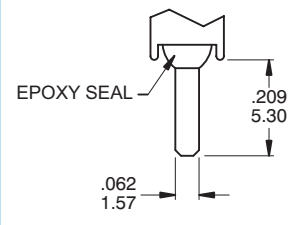

.030(0.76) THK.

M5 WIRE WRAP

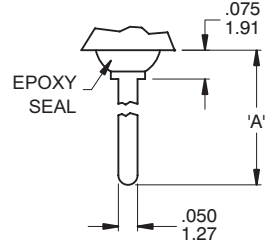

THK .030(0.76)

OTHER TERMINATION OPTIONS

- M6 RIGHT ANGLE P.C. MOUNT
- M7 RIGHT ANGLE P.C. MOUNT
- VS2 VERTICAL BRACKET P.C. MOUNT
- VS3 VERTICAL BRACKET P.C. MOUNT

RE Mating Quick Connector
Amp P / N 60900 - 1

OPTION CODE	DIM. 'A'
M5-1	.736 (18.70)
M5-2	.953 (24.20)
M5-3	.415 (10.55)
M5-4	1.062 (26.97)

M6

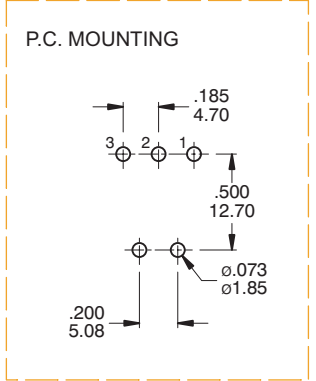
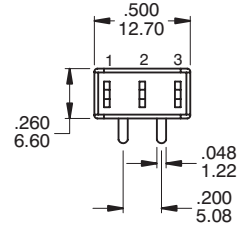
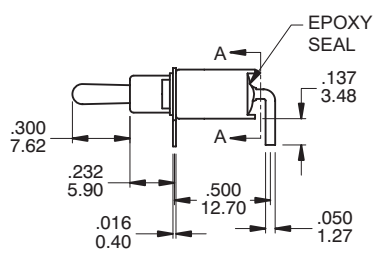
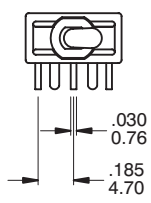
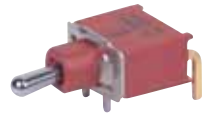

SPDT

Part No. Shown : 1AS1T2B4M6RE

SECTION A-A
TERM. NOS. FOR
REFERENCE ONLY

M6

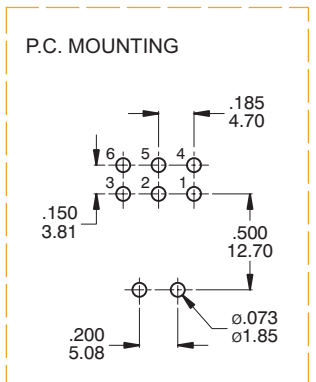
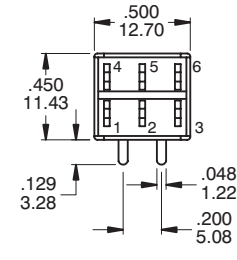
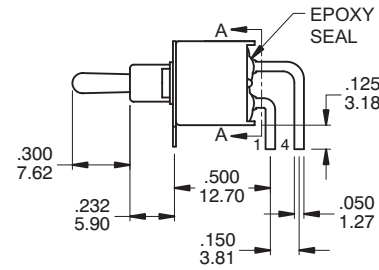
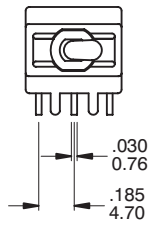

DPDT

Part No. Shown : 1AD1T2B4M6QE

SECTION A-A
TERM. NOS. FOR
REFERENCE ONLY

M7

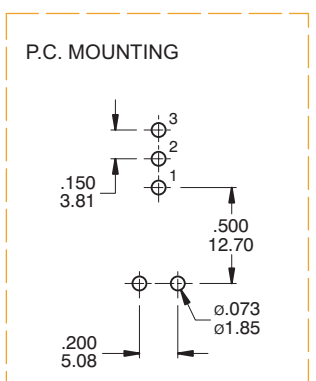
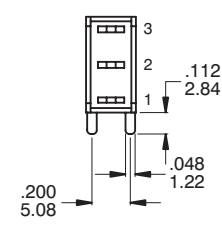
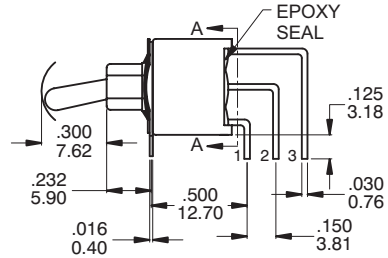
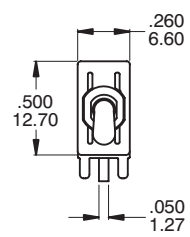
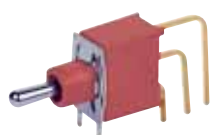

SPDT

Part No. Shown : 1AS1T2B4M7RE

SECTION A-A
TERM. NOS. FOR
REFERENCE ONLY

M7

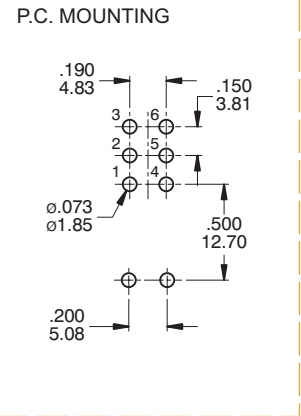
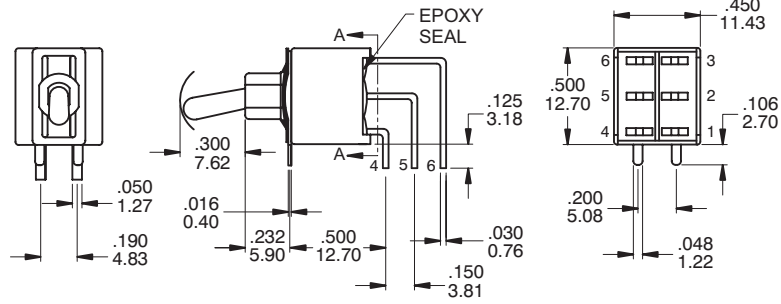
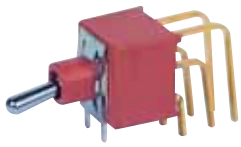

DPDT

Part No. Shown : 1AD1T2B4M7RE

SECTION A-A
TERM. NOS. FOR
REFERENCE ONLY

M7

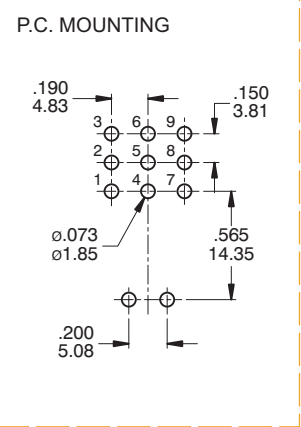
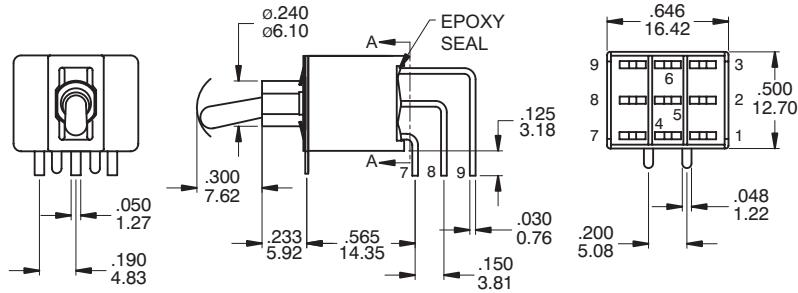
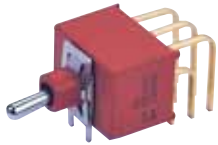

3PDT

Part No. Shown : 1A31T2B4M7RE

SECTION A-A
TERM. NOS. FOR
REFERENCE ONLY

VS2 - VS3

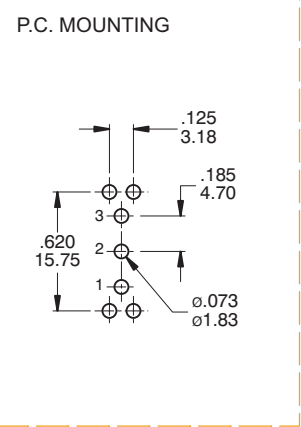
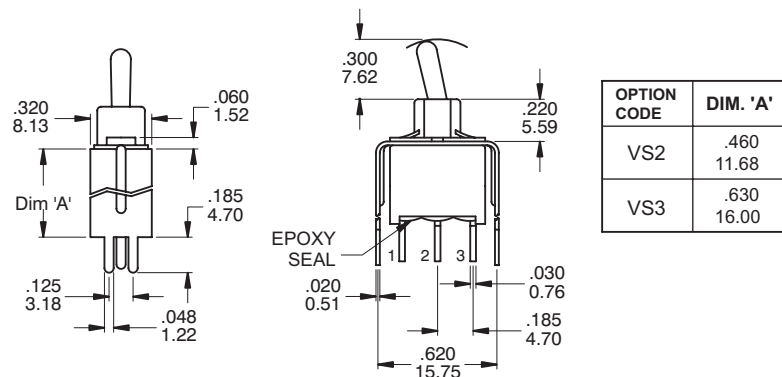

SPDT

Part No. Shown : 1AS1T2B4VS2RE

VS2 - VS3

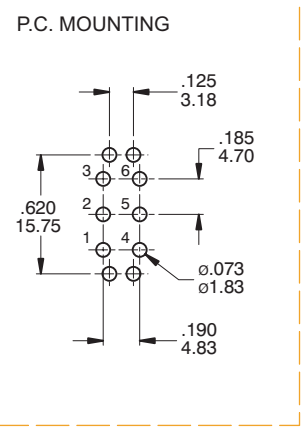
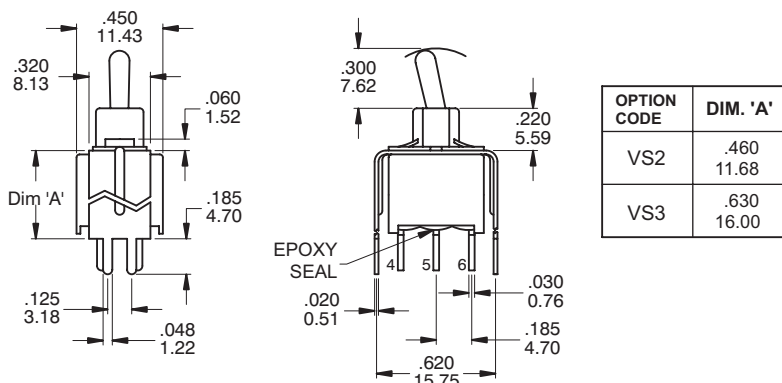

DPDT

Part No. Shown : 1AD1T2B4VS2RE

VS2 - VS3



3PDT

Part No. Shown : 1A31T2B4VS2RE

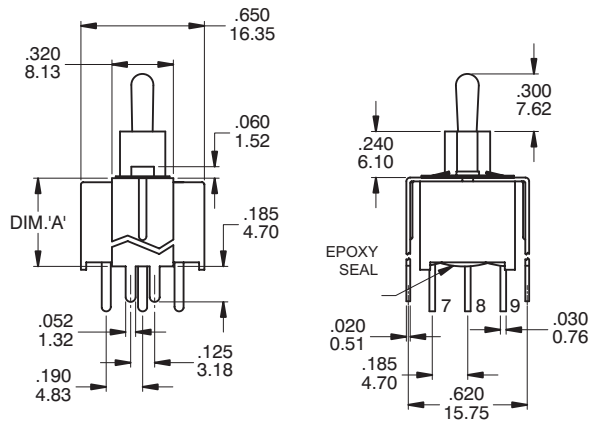

OPTION CODE	DIM. 'A'
VS2	.460 11.68
VS3	.630 16.00

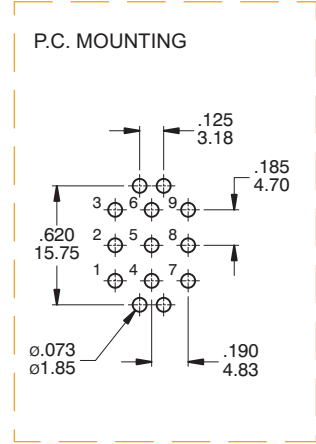

SNAP-IN TERMINATION OPTIONS

M6N

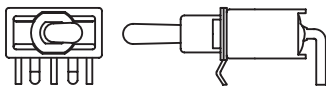

M7N

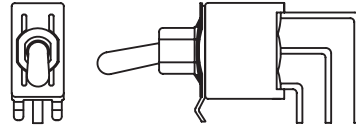

V2N

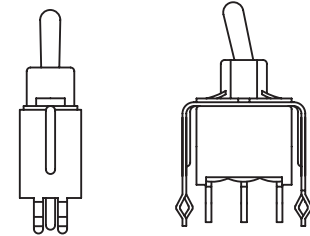

HARDWARE

NUT

HDW2

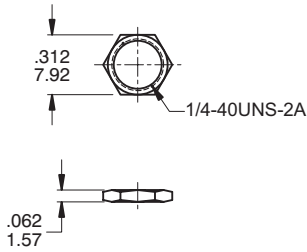

LOCKING RING

HDW15

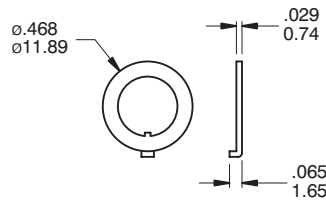

LOCK WASHER

HDW11

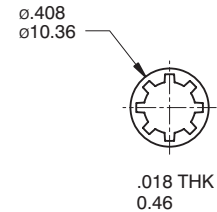

CONTACT MATERIAL OPTIONS

	CONTACT MATERIAL	TERMINAL PLATING	RATINGS
Q	Silver	Q = Gold flash over silver	5 Amps with resistant load @ 120VAC or 28VDC 2 Amps with resistant load @ 250VA
S		S = Gold flash over silver,pure - tin	
C	Gold over Silver	C = Gold over silver	
K		K = Gold over silver,pure - tin	
R	Gold	R = Gold	0.4 Volt - Amps (VA) max. @ 20V max. (AC or DC)
G		G = Gold,pure - tin	



IP 67
 ACCORDING TO
 EN 60529:1991+A1:2001
 IEC 60529:2001

SOLDERING PROCESSES

MANUAL SOLDERING : Use soldering iron of 30 watts, controlled st 350°C approximately 5 seconds while applying solder.

WAVE SOLDERING : Recommended Soldering Temperature : 260 ± 5°C
 Duration of Solder Immersion : 5 ± 1 seconds
 (PCB is 1.6mm in thickness)

SOLDERING : Vapor phase

