

SPECIFICATIONS

- CONTACT RATING:** 0.4 VA max. @ 20 V AC or DC max.
- MECHANICAL LIFE:** 50,000 make-and-break cycles.
- CONTACT RESISTANCE:** 100mΩ typ. initial @ 2-4VDC,100mA.
- INSULATION RESISTANCE:** DC500V 500MΩ.
- DIELECTRIC STRENGTH:** 500 V RMS min@sea level.
- OPERATING TEMPERATURE:** -30°C to 85°C.

MATERIALS

- CASE & BUSHING :** Glass filled nylon 6/6, flame retardant, heat stabilized (UL94V-0).
- ACTUATOR:** Nylon, black std.
- SWITCH SUPPORT:** Brass or steel, tin plated.
- CONTACTS/TERMINALS:** Silver or gold plated copper alloy.

Rocker Switches

HOW TO ORDER

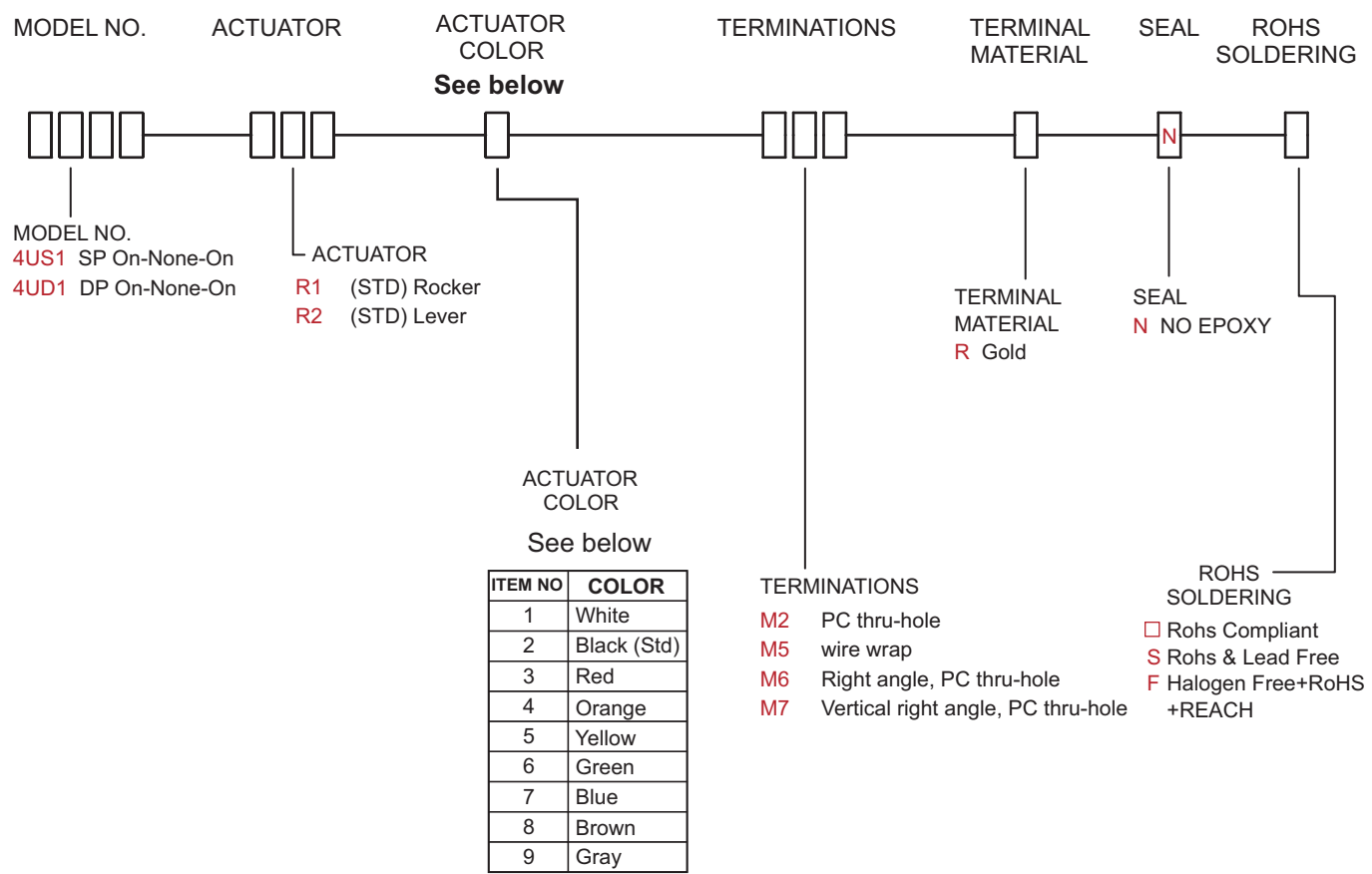

ITEM NO	COLOR
1	White
2	Black (Std)
3	Red
4	Orange
5	Yellow
6	Green
7	Blue
8	Brown
9	Gray

SWITCH FUNCTION

NO. POLES	MODEL NO.	SWITCH FUNCTION			CONNECTED TERMINALS / SCHEMATIC		
		POS.1	POS.2	POS.3	POS.1	POS.2	POS.3
SP	4US1	ON	NONE	ON		OPEN	
DP	4UD1	ON	NONE	ON		OPEN	

MOM=MOMENTARY

ACTUATOR OPTIONS / PANEL MOUNT

R1

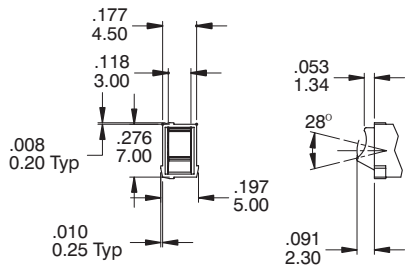

R2

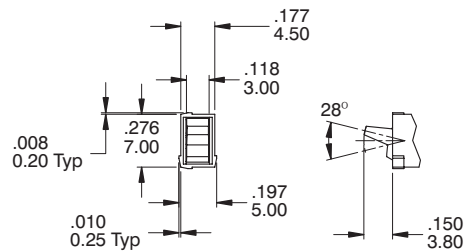

POLE OPTIONS

M2

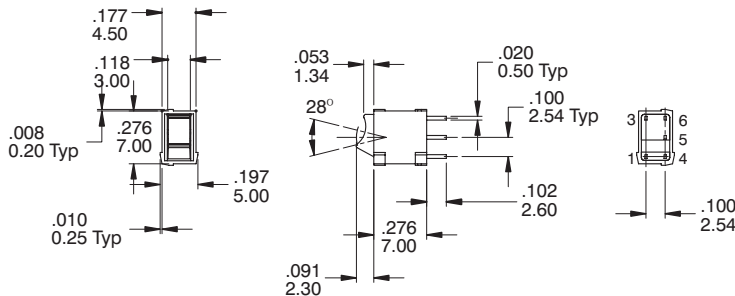
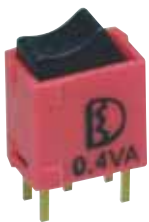

P.C. MOUNTING

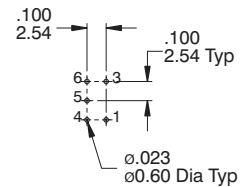

SPDT

Part No. Shown : 4US1R102M2RNS

M2

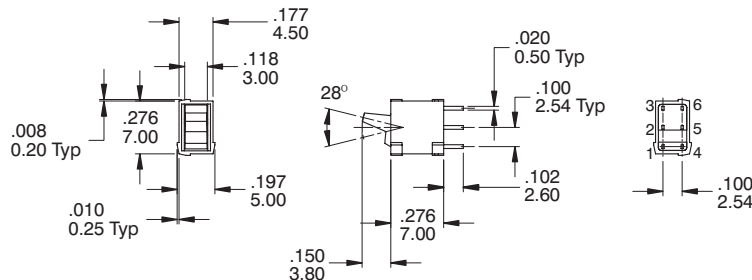

P.C. MOUNTING

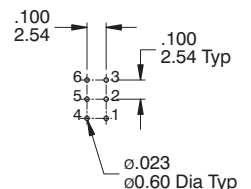

SPDT

Part No. Shown : 4UD1R202M2RNS

Sub-Miniature Rocker Switches **4U SERIES**

Rocker Switches

M6

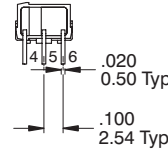
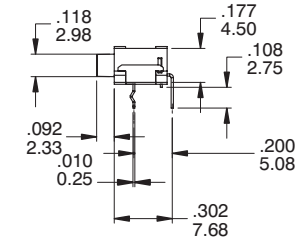
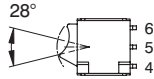
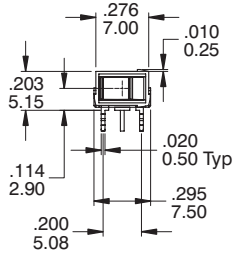

P.C. MOUNTING

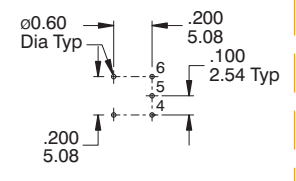

SPDT

Part No. Shown : 4US1R102M6RNS

M6

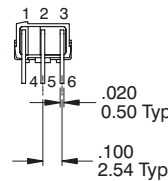
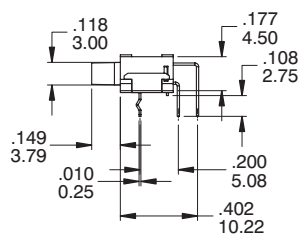
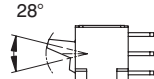
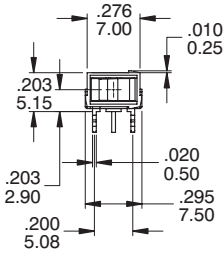
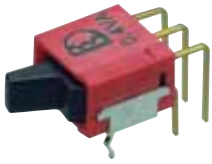

P.C. MOUNTING

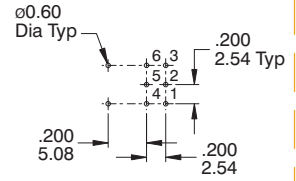

DPDT

Part No. Shown : 4UD1R202M6RNS

M7

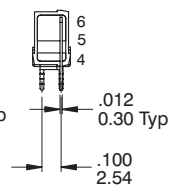
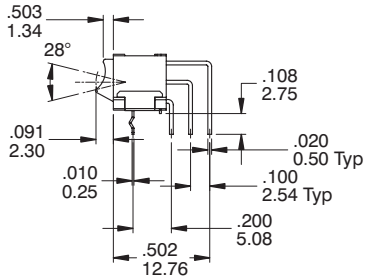
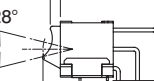
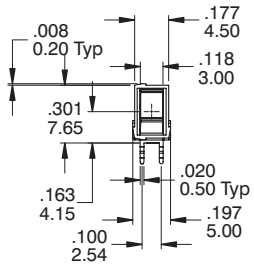

P.C. MOUNTING

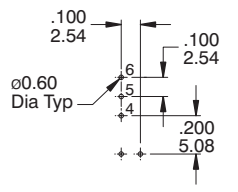

SPDT

Part No. Shown : 4US1R102M7RNS

M7

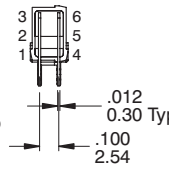
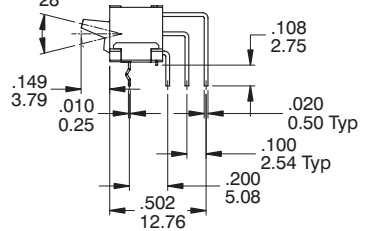
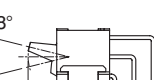
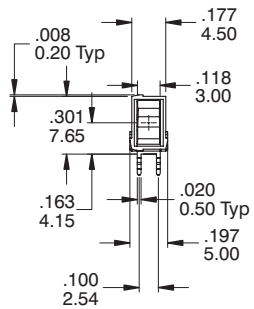

P.C. MOUNTING

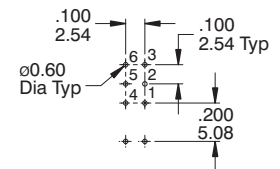

DPDT

Part No. Shown : 4UD1R202M7RNS



SOLDERING PROCESSES

WAVE SOLDERING : Recommended Soldering Temperature : $260 \pm 5^{\circ}\text{C}$
 Duration of Solder Immersion : 5 ± 1 seconds
 (PCB is 1.6mm in thickness)

SOLDERING : Vapor phase

