

# RA(R19A) Series

## Rocker Switches



RA(R19A) Rocker Switches



### SPECIFICATION

Electrical Rating : 2A 125V AC/250V AC(UL,VDE)  
 6A 250V AC(standard)(UL,VDE)  
 15A 125V AC & 8A 250V AC(UL)

Mechanical life: Over 30000 cycles  
 Electrical life: Over 10000 cycles  
 Contact resistance: <20mΩ  
 Insulation resistance: >1000MΩ  
 High voltage resistance: >1500VAC 1 min.  
 Ambient temperature: Terminal side -20 to +85°C  
 Actuating side- 20 to +55°C

Atmospheric humidity: Max.85%  
 Actuating force: 3 to 6N(depends on different switch function)  
 Flammability: UL94V-2 & UL94V-0  
 Storage temperature: -30 to +80°C Max  
 Temperature rise at the terminal: Max 30°C (UL1054)  
 Solder ability of terminal: Max 350°C 3s

### MATERIALS

Housing: PA 66  
 Rocker: PA 66 & PC  
 Contacts: Silver alloy  
 Terminal: Copper or brass silver plated,phosphorus bronze  
 Spring: SWC  
 Movable arm: Copper silver plated  
 Lamp: LED  
 Bracket: PA66

### HOW TO ORDER

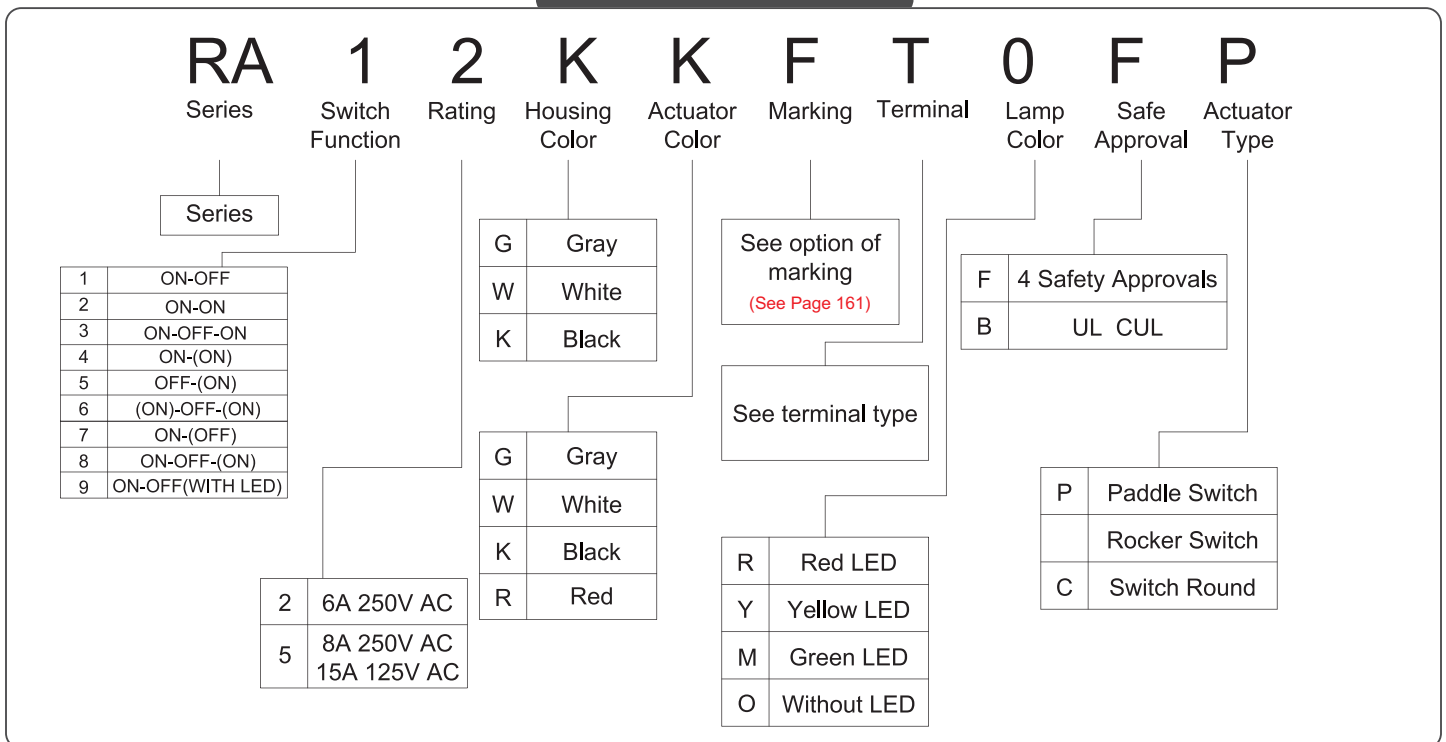

### OPTION OF SWITCH FUNCTION

Item No	POLES & THROWS	Rocker position ( ):Momentary		
		Left	Center	Right
RA1	SPST	ON	None	OFF
RA2	SPDT	ON	None	ON
RA3	SPDT	ON	OFF	ON
RA4	SPDT	ON	None	(ON)
RA5	SPST	OFF	None	(ON)
RA6	SPDT	(ON)	OFF	(ON)
RA7	SPST	ON	None	(OFF)
RA8	SPDT	ON	OFF	(ON)
RA9	SPST (With LED)	ON	None	OFF

### DIMENSION

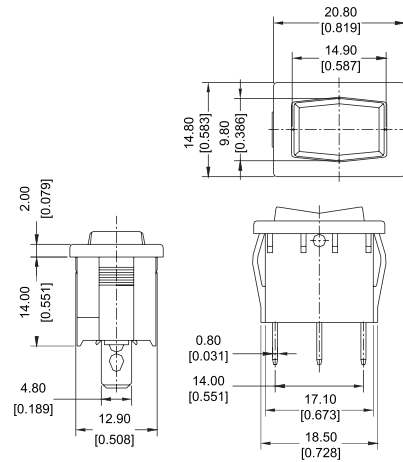

### PANEL CUT OUT

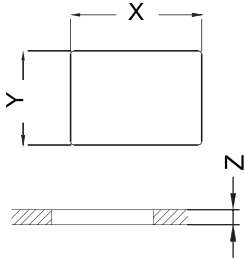

Z	Y	X
0.7~1.25	12.8~12.9	19.2~19.3
1.25~2.0	12.8~12.9	19.3~19.4
2.0~3.0	12.8~12.9	19.5~19.6

### CIRCUITS FOR SWITCH WITH LAMP

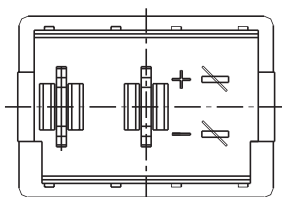

CIRCUIT FOR LOAD

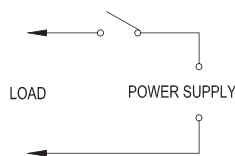

CIRCUIT FOR LED

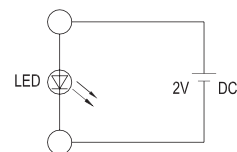

### TERMINAL TYPE

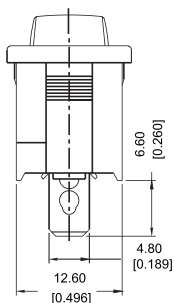

T&H

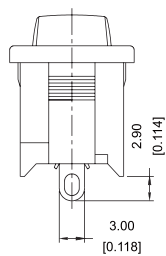

S

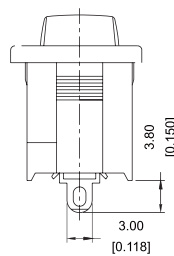

W

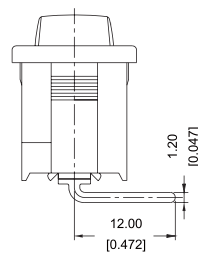

R

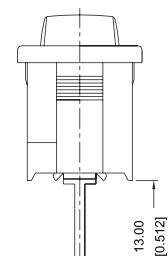

P

T(Quick connect tab:Thickness of 0.8mm)  
H(Quick connect tab:Thickness of 0.5mm)